

All property rights and rights to exploitation of copyright for this drawing data remain ours; they may not be made available to third parties without our consent.

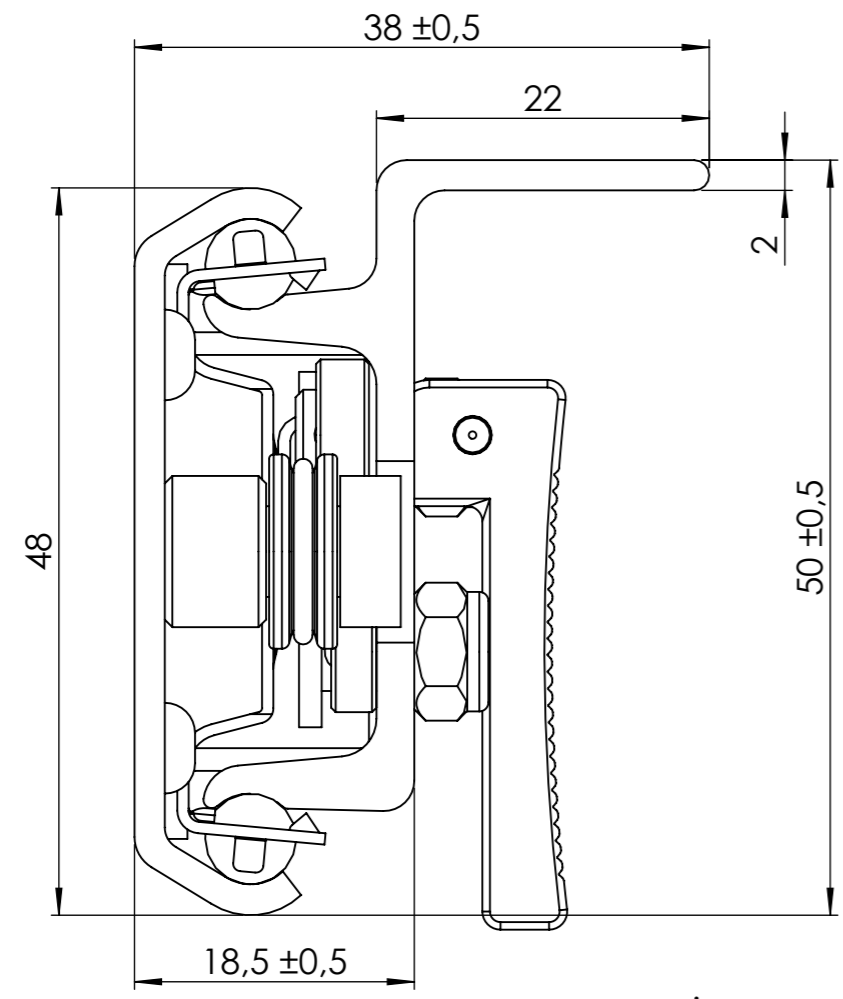

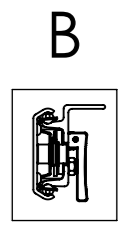

DETAIL B 2 : 1

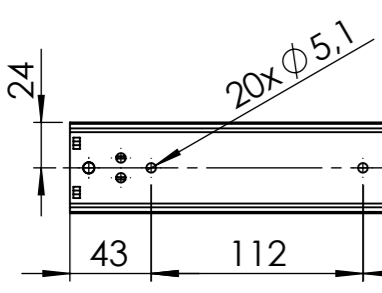
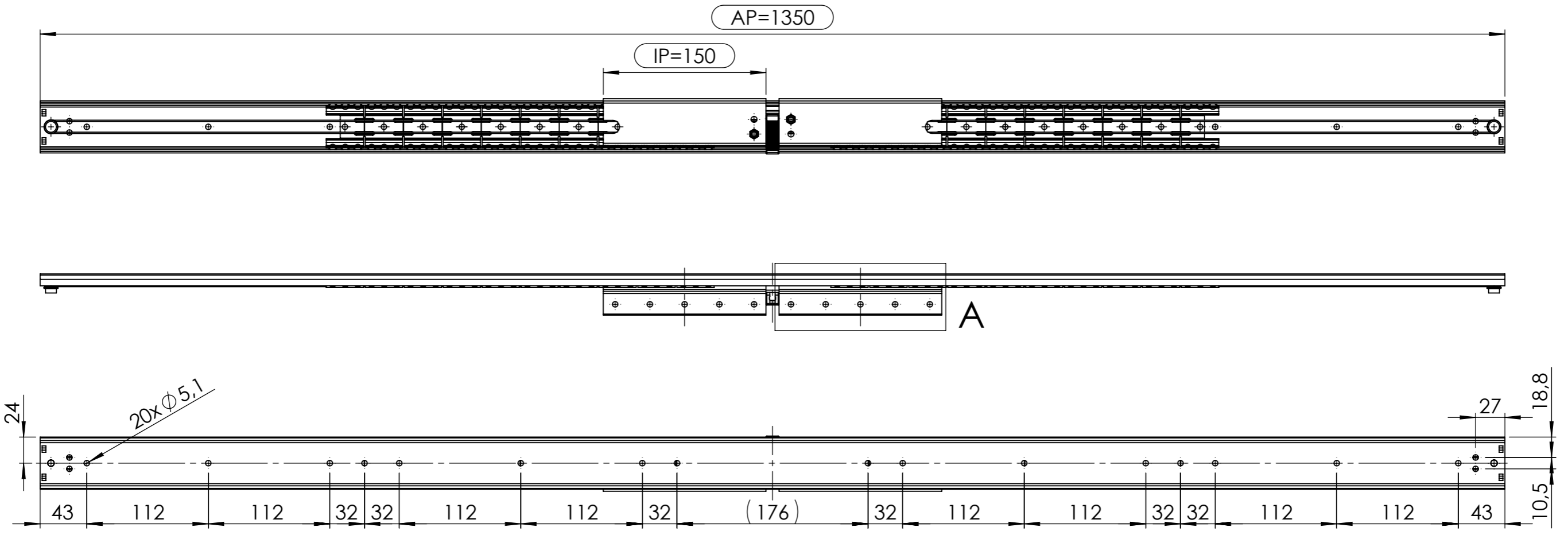
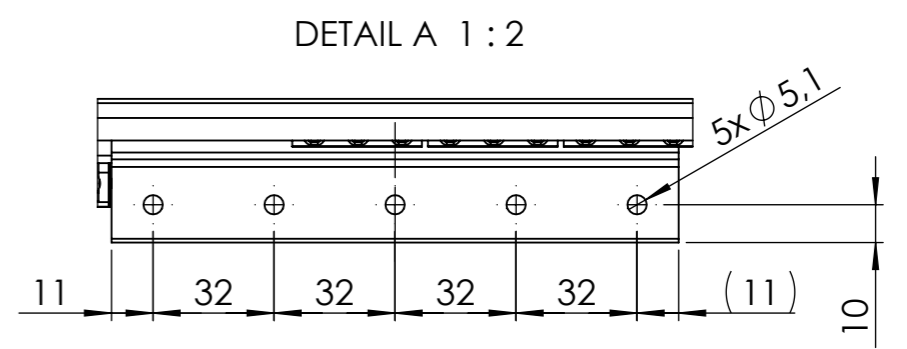

DETAIL A 1 : 2

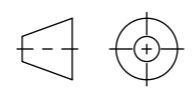
opening : ca.1038 mm

Index	Change			Date	Name
 DIN ISO 128-30	Description: BA-SB/1350.4/150.A4/KK10				
	Surface: diverse		Material: diverse		Weight: 1.84 kg
 PÖTTKER Transforming furniture	Name	Date	Company		
	Signed	Vaquero	27.09.12		
	Tested	J. Vaquero	10.01.2017	Second Company:	
General tolerance: DIN ISO 2768 - m		Item No:	47135201	Scale 1:4	Page 1/3
					A3

All property rights and rights to exploitation of copyright for this drawing data remain ours; they may not be made available to third parties without our consent.

CLOSE

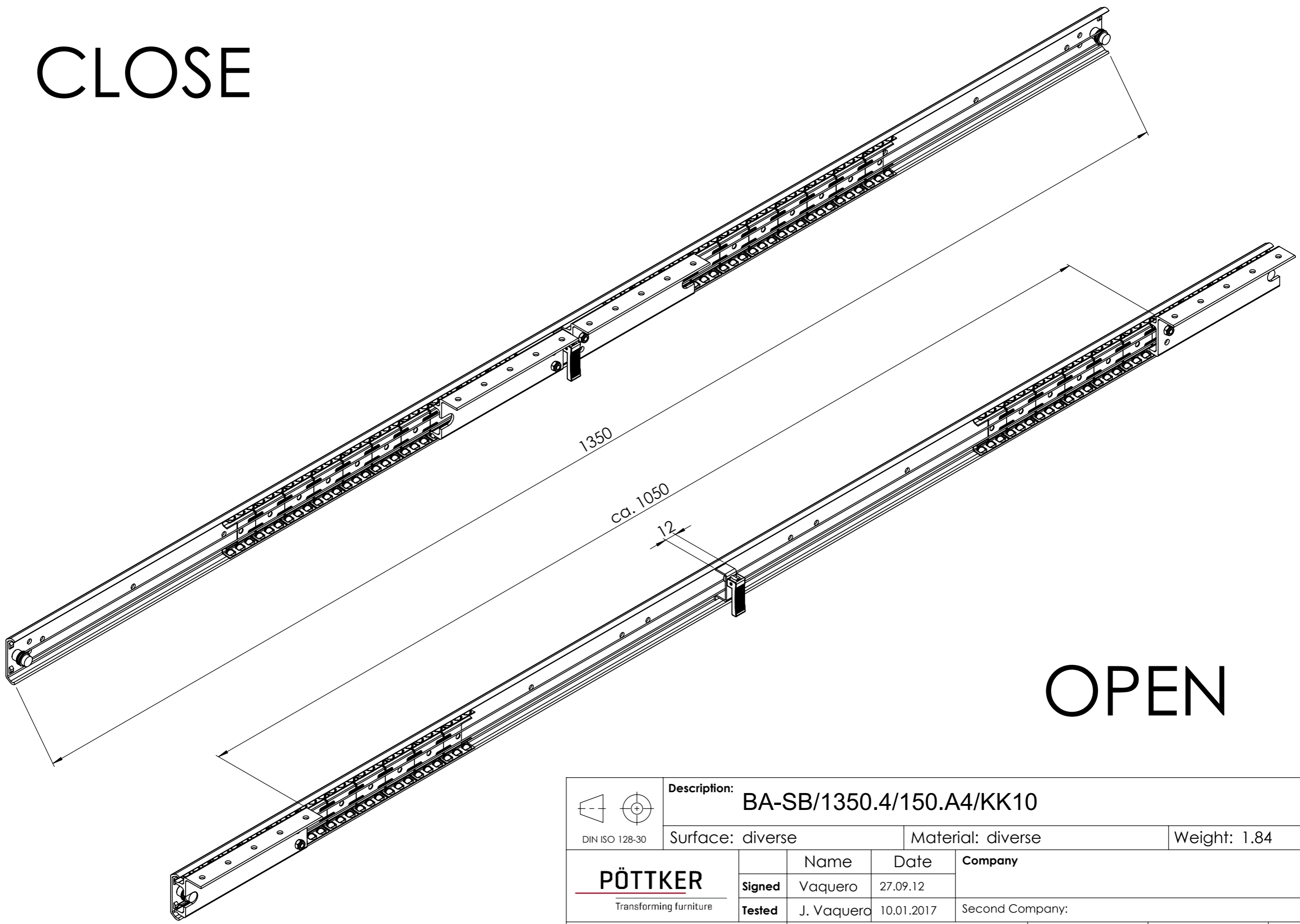

OPEN

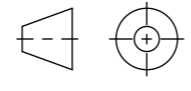
 DIN ISO 128-30	Description: BA-SB/1350.4/150.A4/KK10					
	Surface: diverse		Material: diverse		Weight: 1.84 kg	
PÖTTKER Transforming furniture	Name	Date	Company			
	Signed	Vaquero	27.09.12	Second Company:		
	Tested	J. Vaquero	10.01.2017			
General tolerance: DIN ISO 2768 - m		Item No:	47135201	Scale 1:3	Page 2/3	A3

All property rights and rights to exploitation of copyright for this drawing data remain ours; they may not be made available to third parties without our consent.

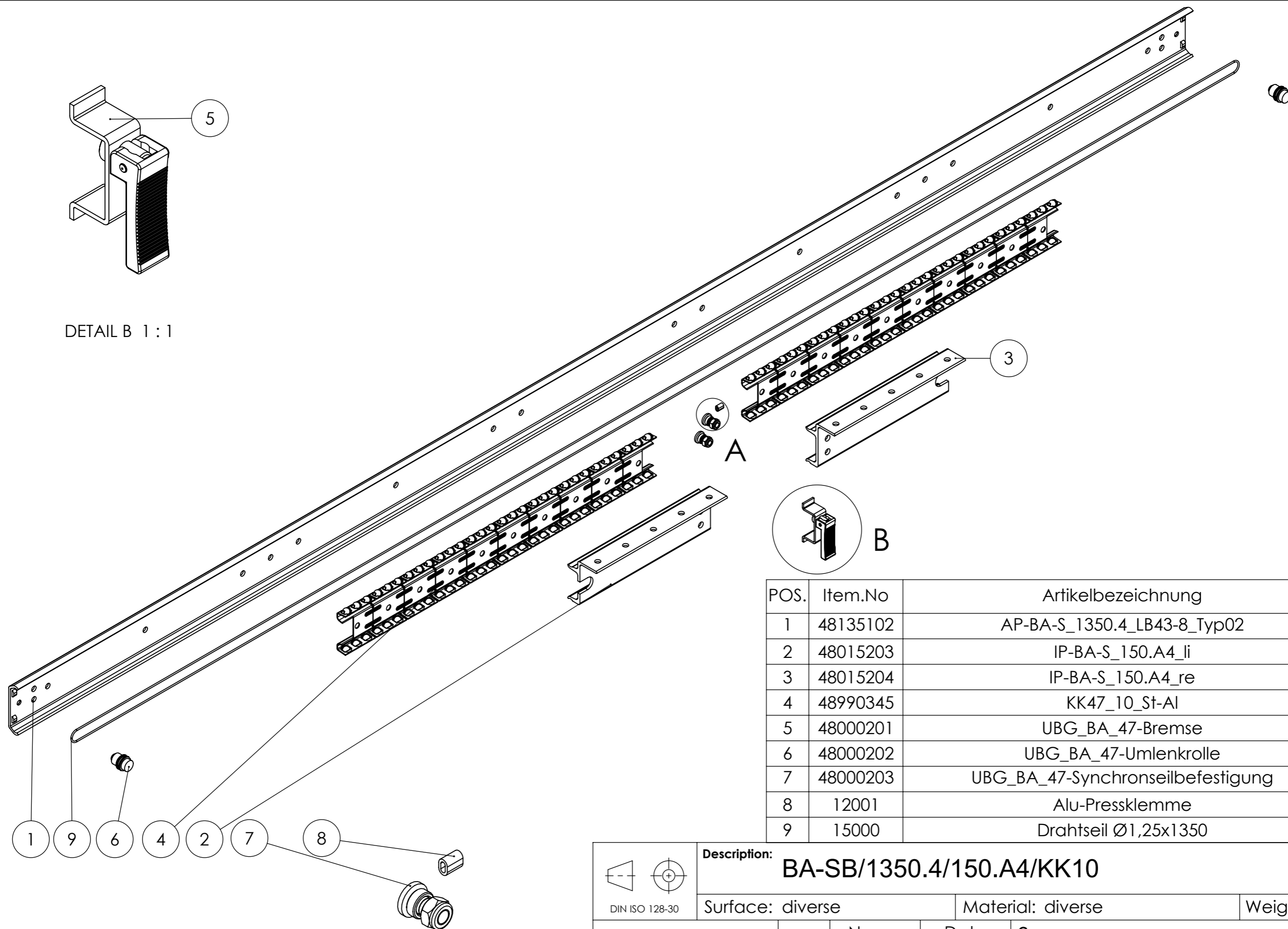

DETAIL B 1 : 1

DETAIL A 1 : 1

POS.	Item.No	Artikelbezeichnung	Menge x2
1	48135102	AP-BA-S_1350.4_LB43-8_Typ02	1
2	48015203	IP-BA-S_150.A4_li	1
3	48015204	IP-BA-S_150.A4_re	1
4	48990345	KK47_10_St-Al	2
5	48000201	UBG_BA_47-Bremse	1
6	48000202	UBG_BA_47-Umlenkrolle	2
7	48000203	UBG_BA_47-Synchronseilbefestigung	2
8	12001	Alu-Pressklemme	1
9	15000	Drahtseil Ø1,25x1350	1

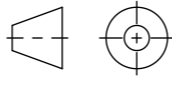
 DIN ISO 128-30	Description: BA-SB/1350.4/150.A4/KK10		
	Surface: diverse		Material: diverse
Weight: 1.84 kg			
PÖTTKER Transforming furniture	Name	Date	Company
	Signed	Vaquero	27.09.12
	Tested	J. Vaquero	10.01.2017
Second Company:			
General tolerance: DIN ISO 2768 - m		Item No: 47135201	Scale 1:3
Page 3/3		A3	